

1

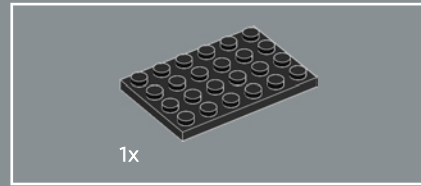

2

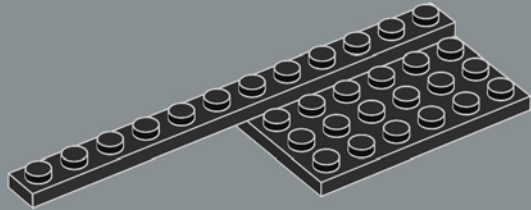

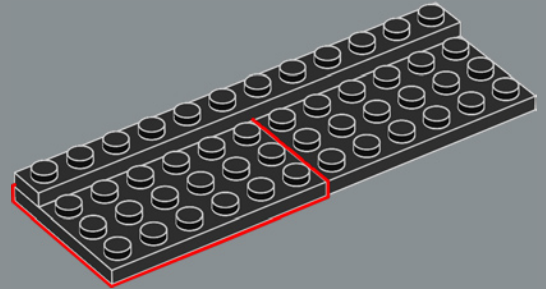
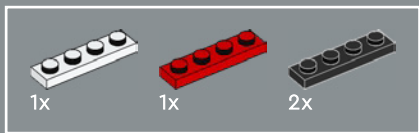

3

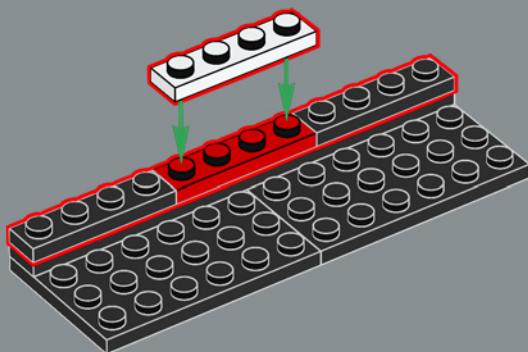

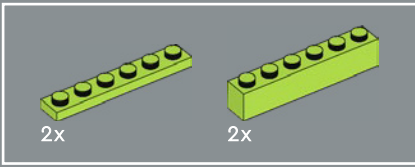

4

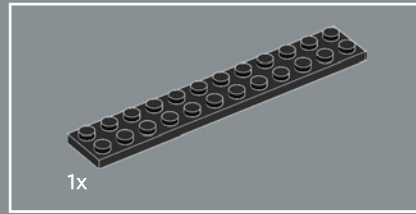
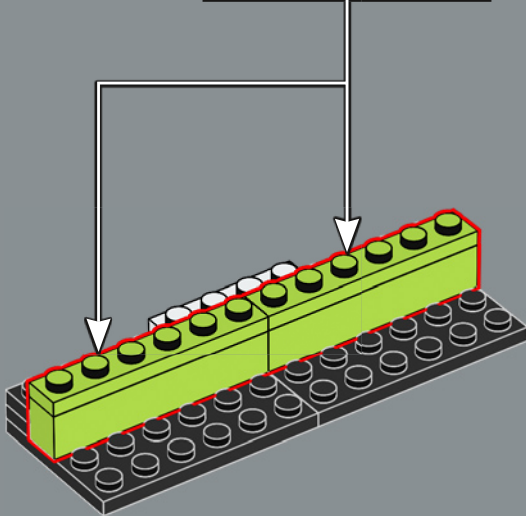
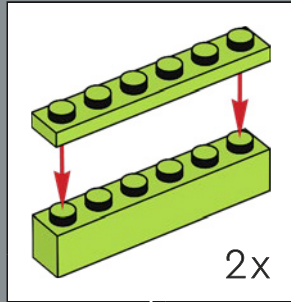

5

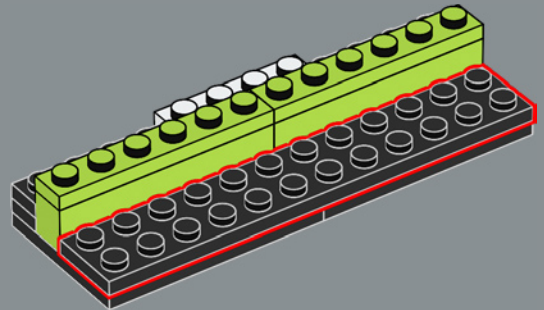

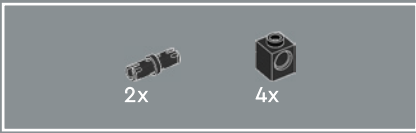

6

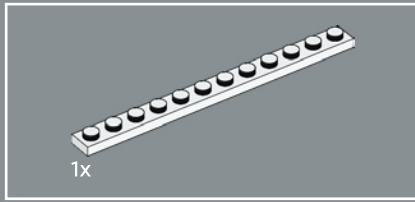
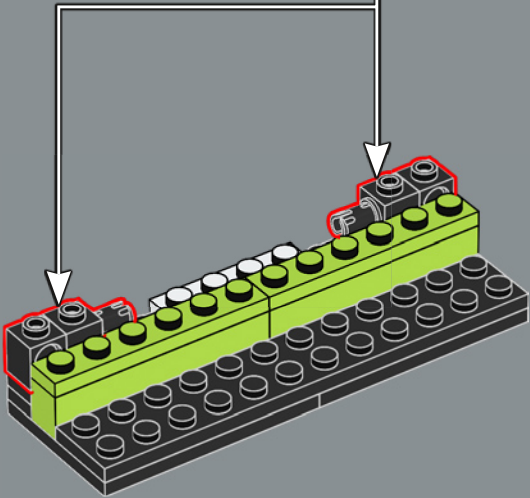
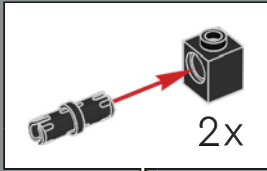

7

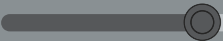
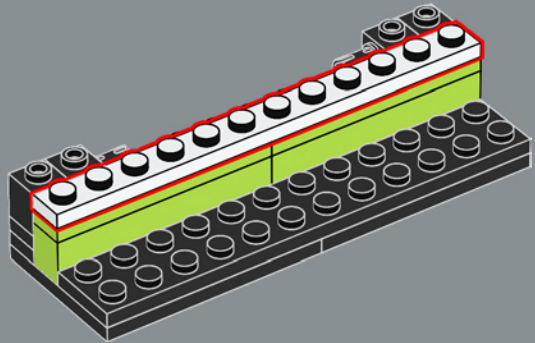

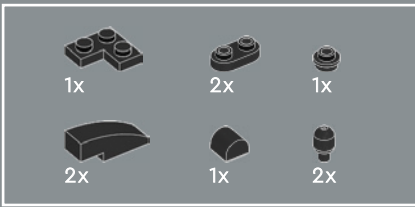

8

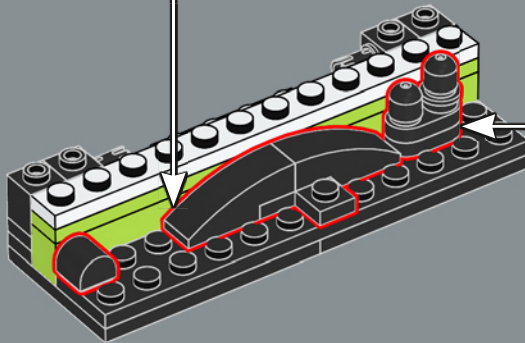
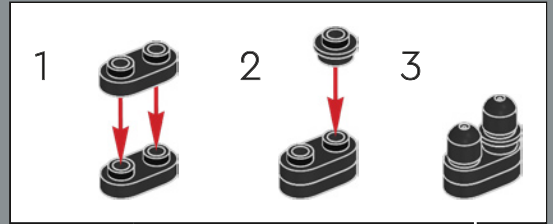
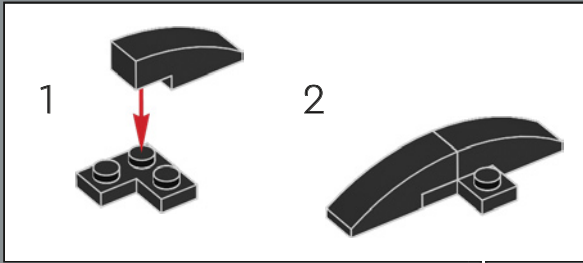



9

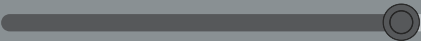
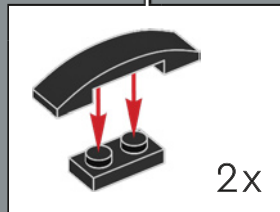
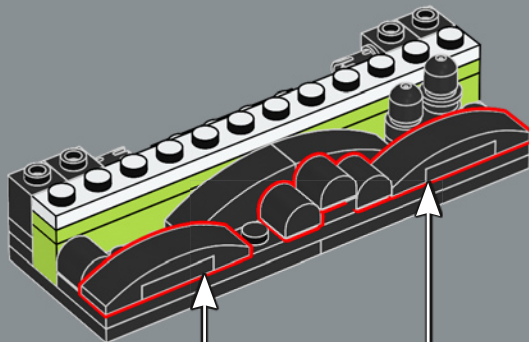



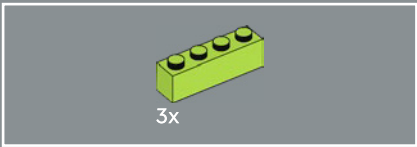

10

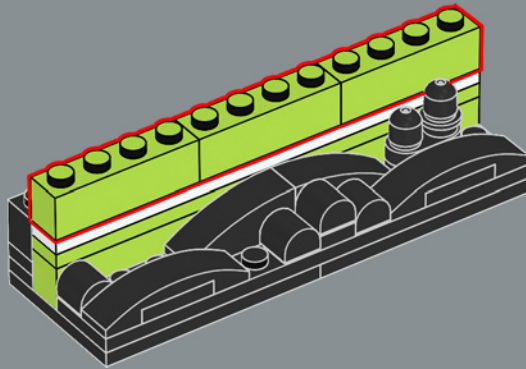
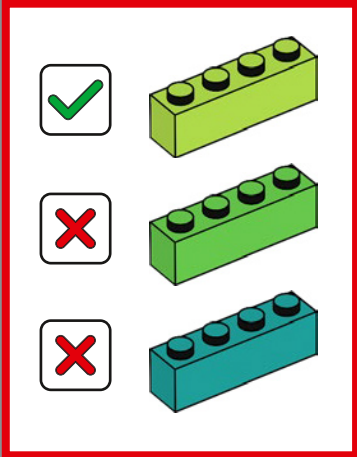

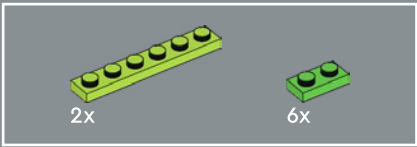

11

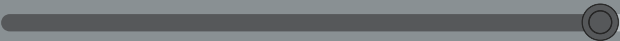
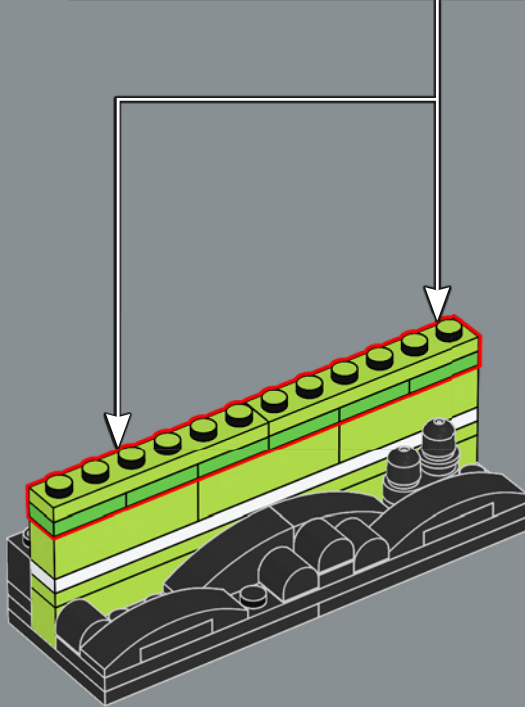
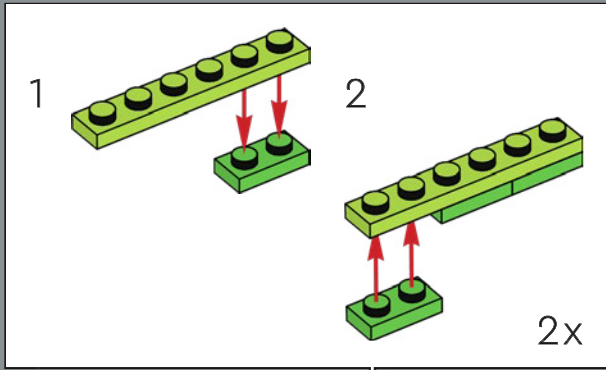

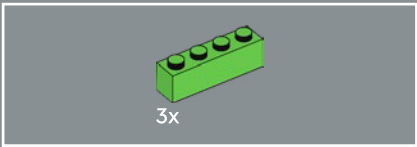

12

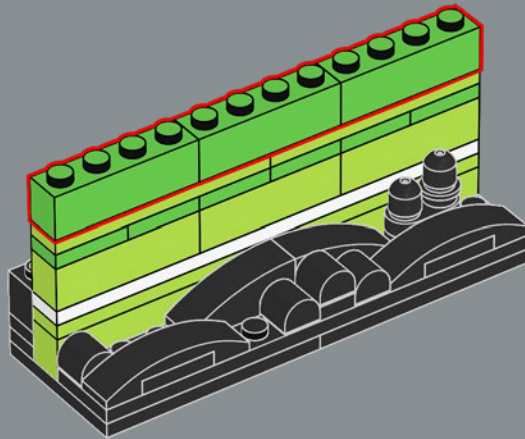
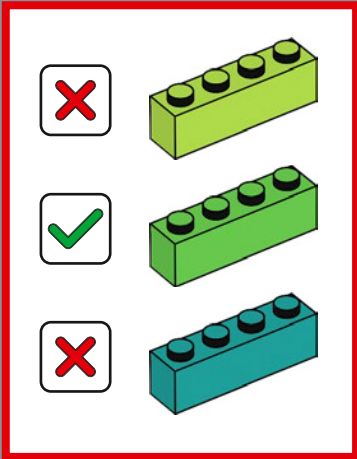

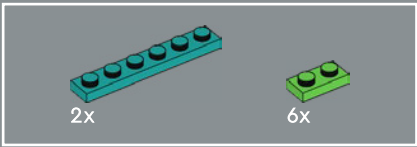

13

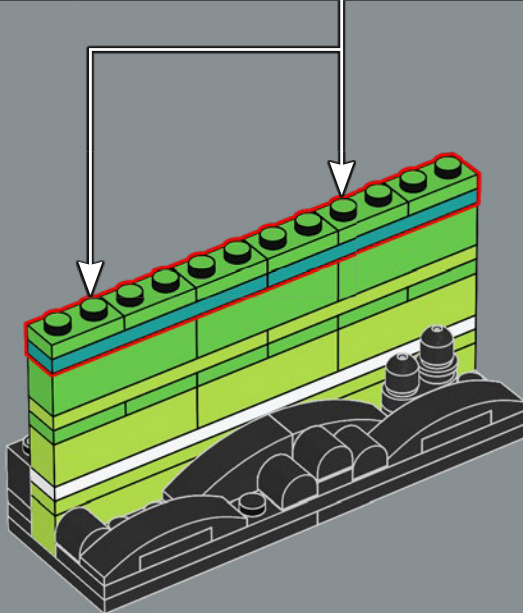
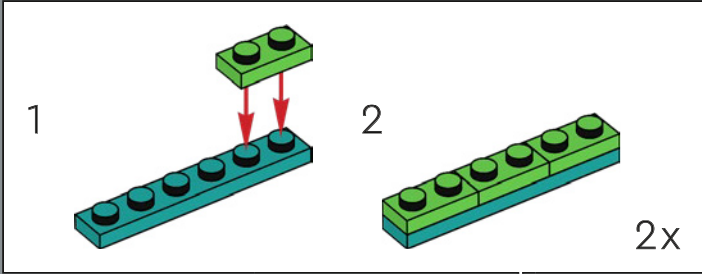

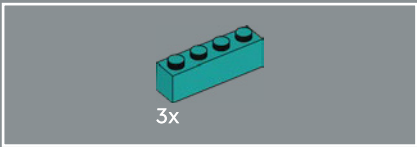

14

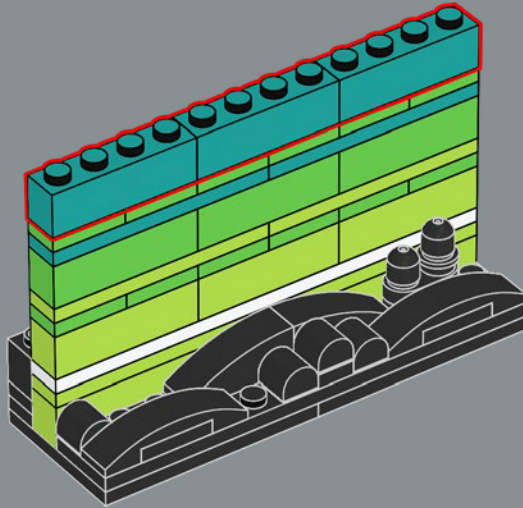
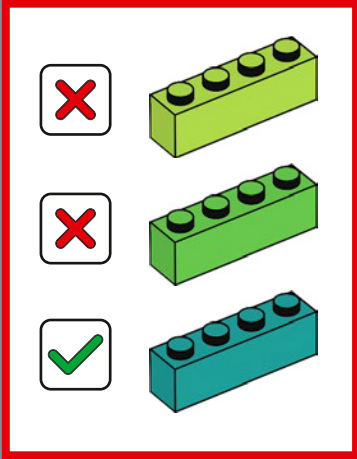

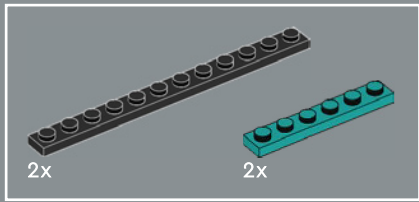

15

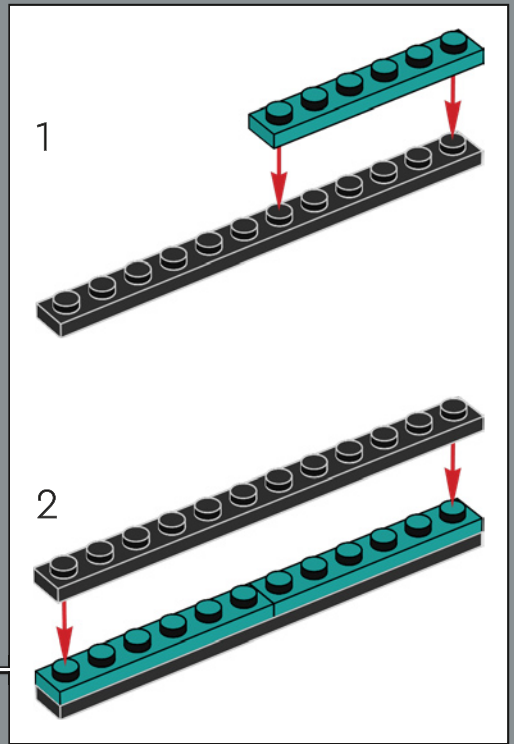
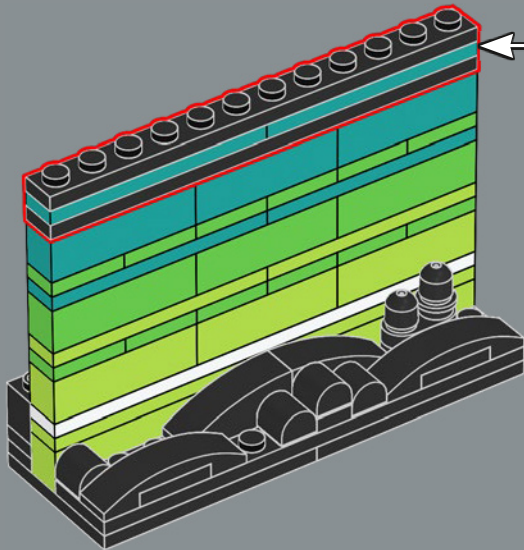

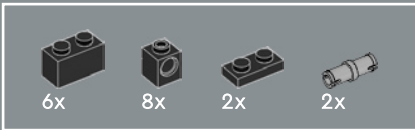

16

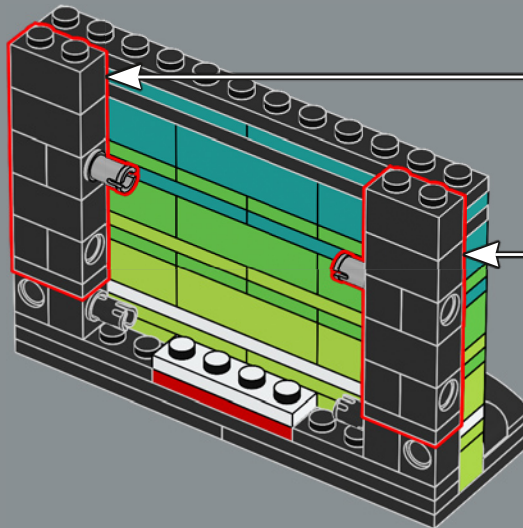
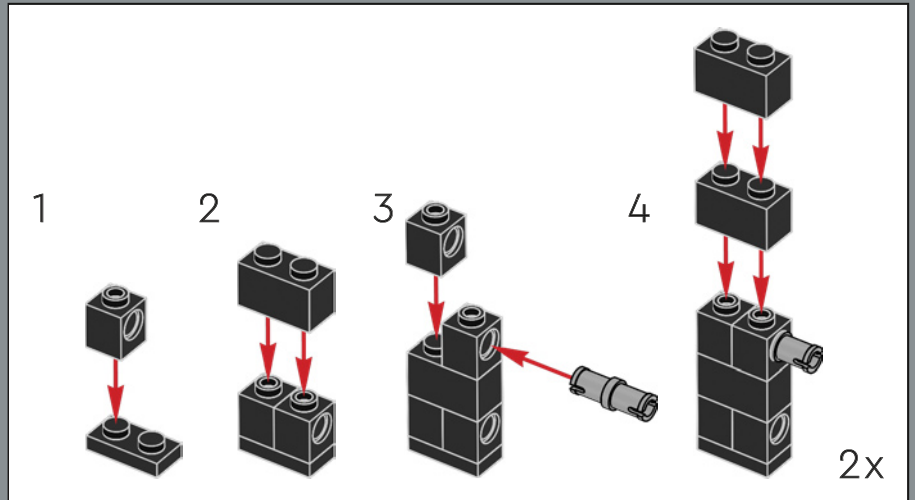

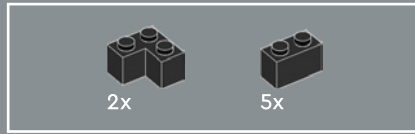

17

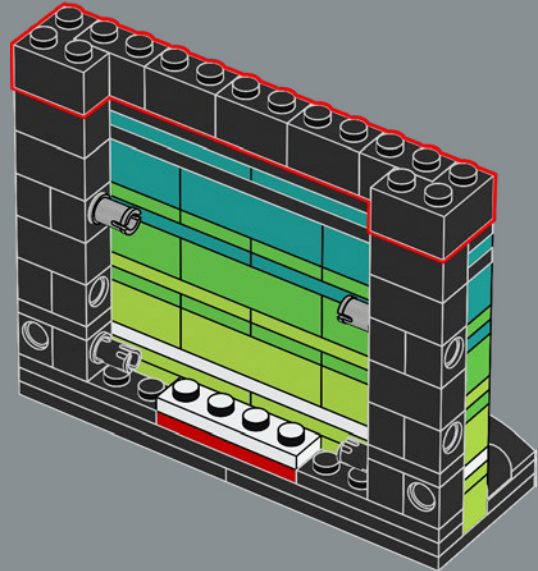



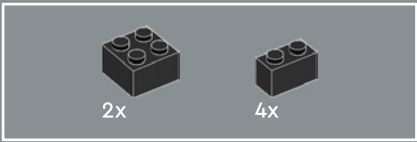

18

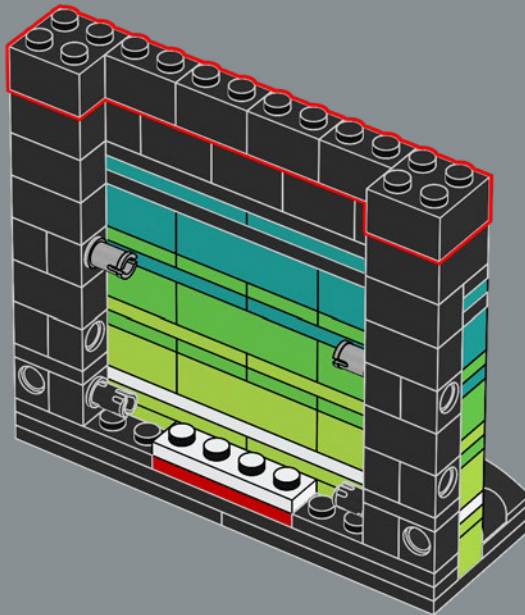

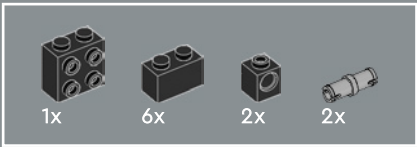

19

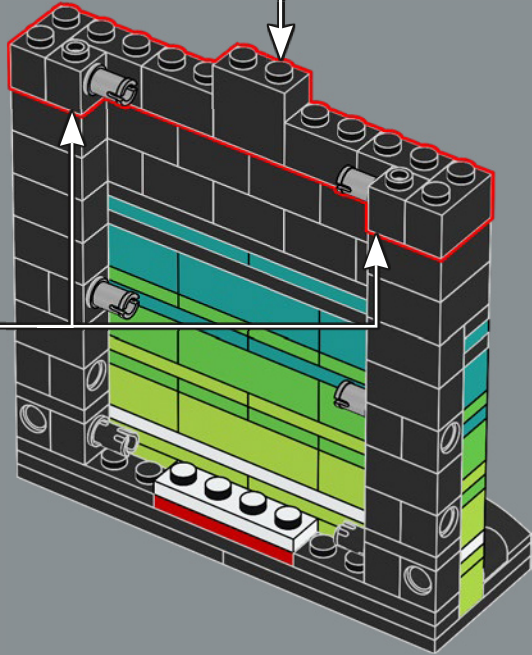
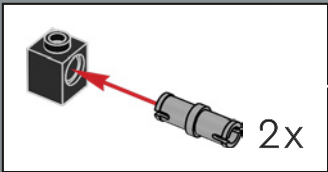
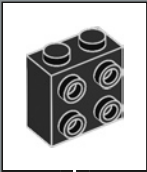

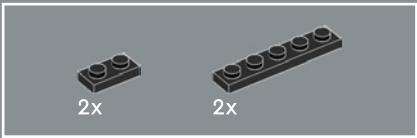

20

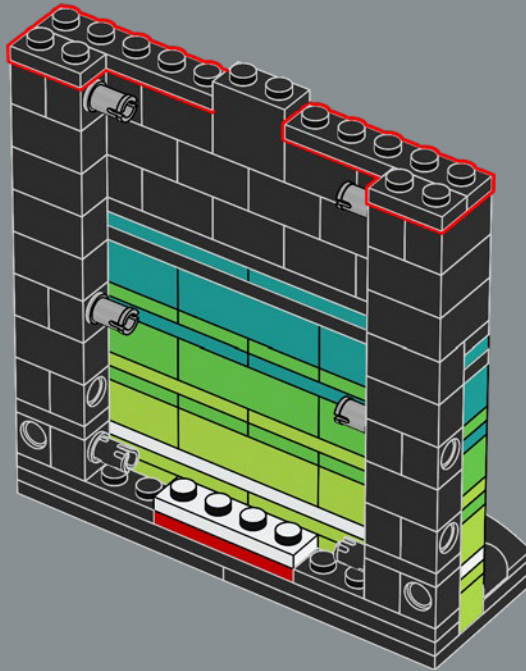

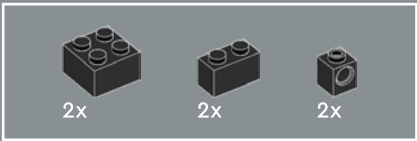

21

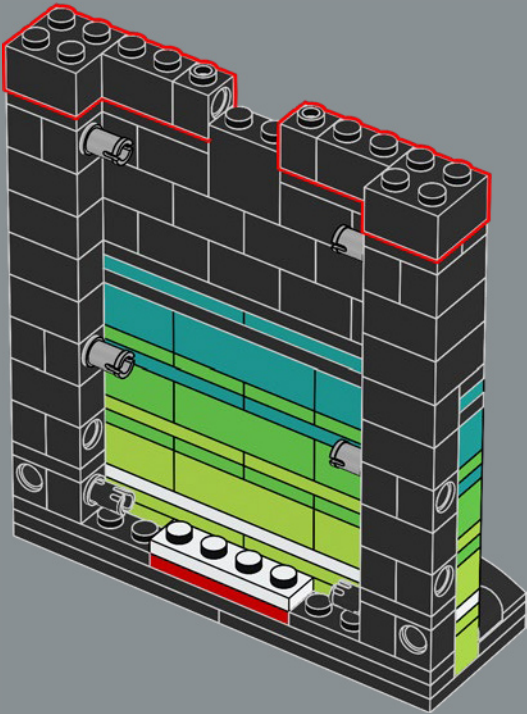



2x



2x

22

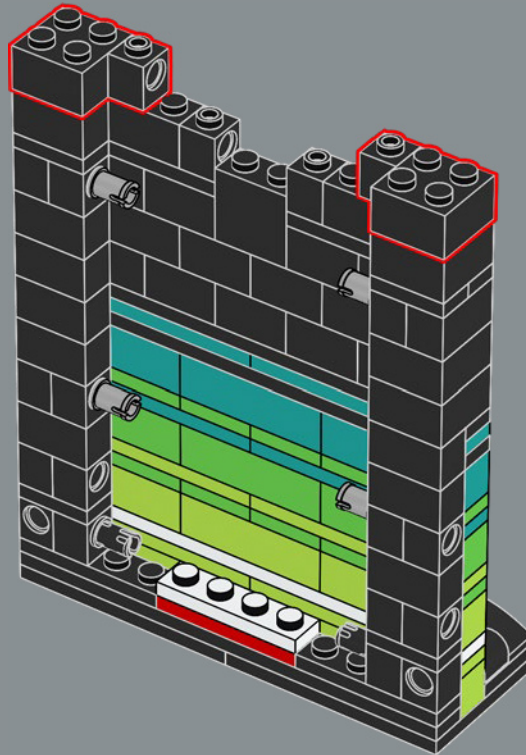



23

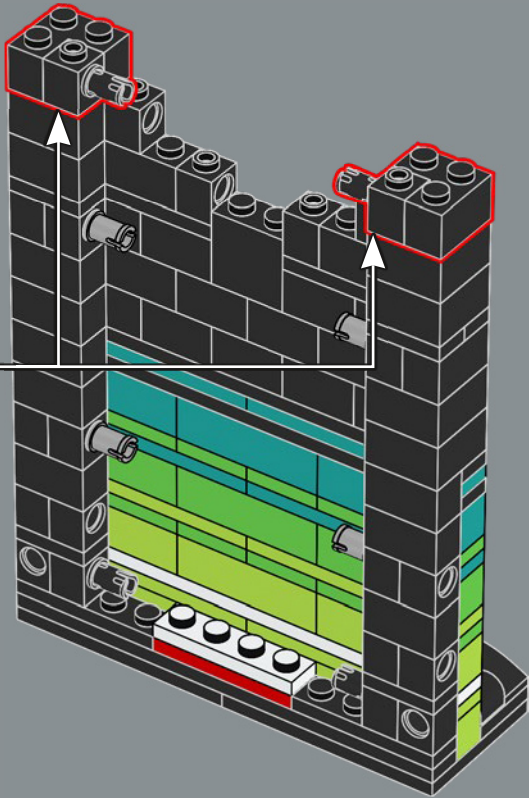
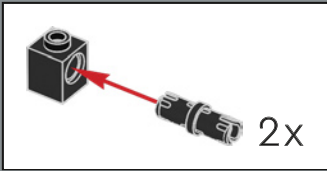

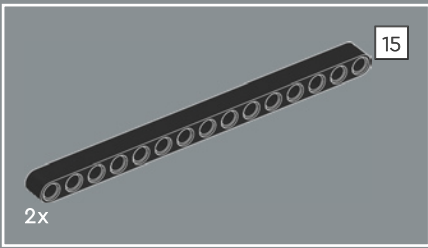

24

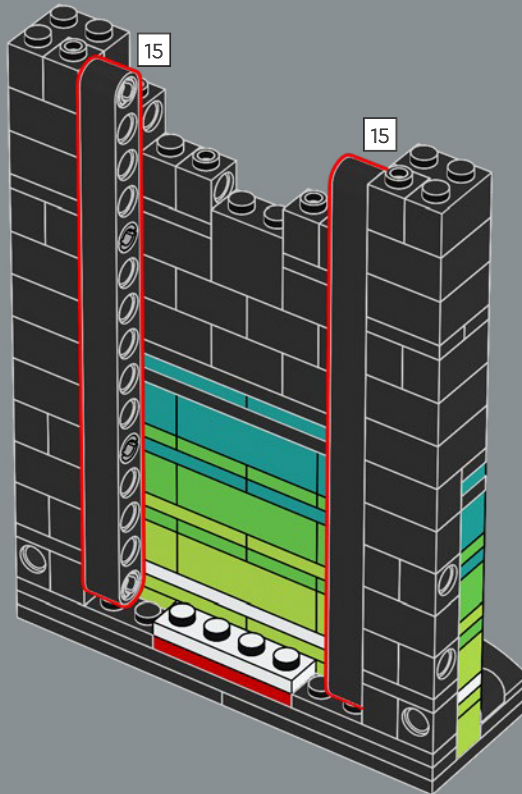

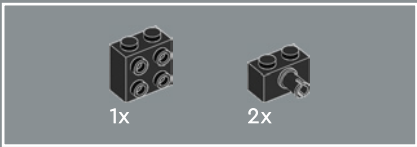

25

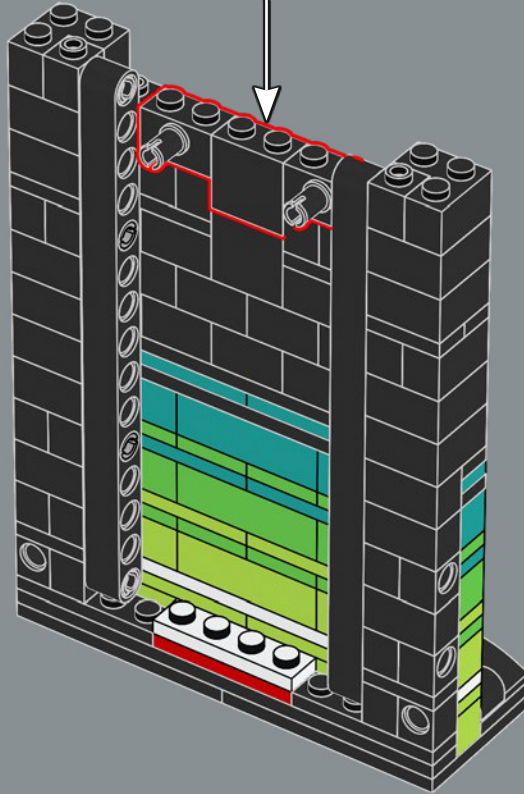
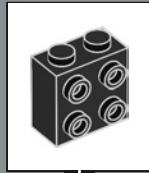



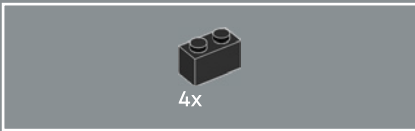

26

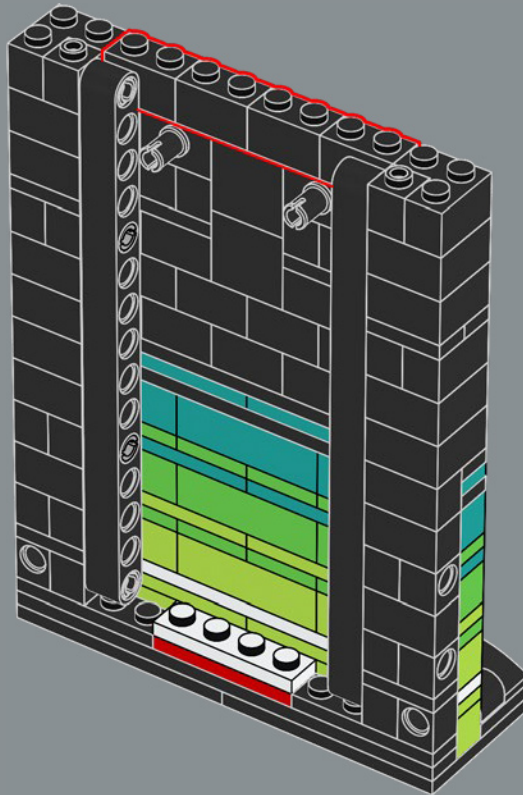

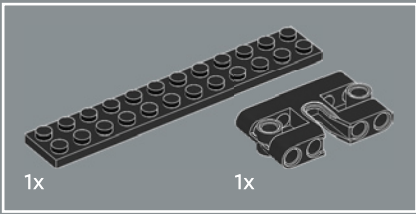

27

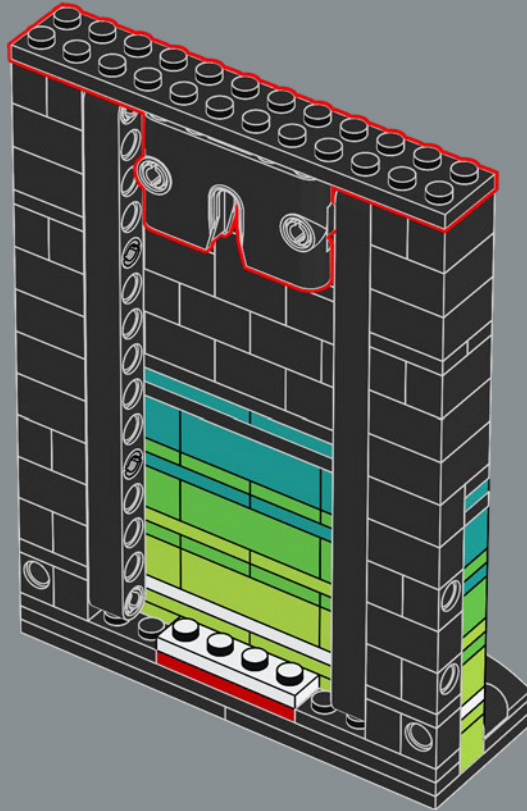

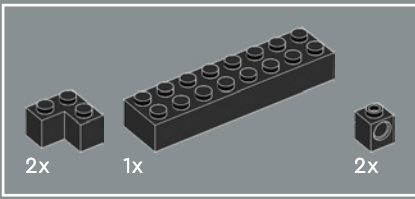

28

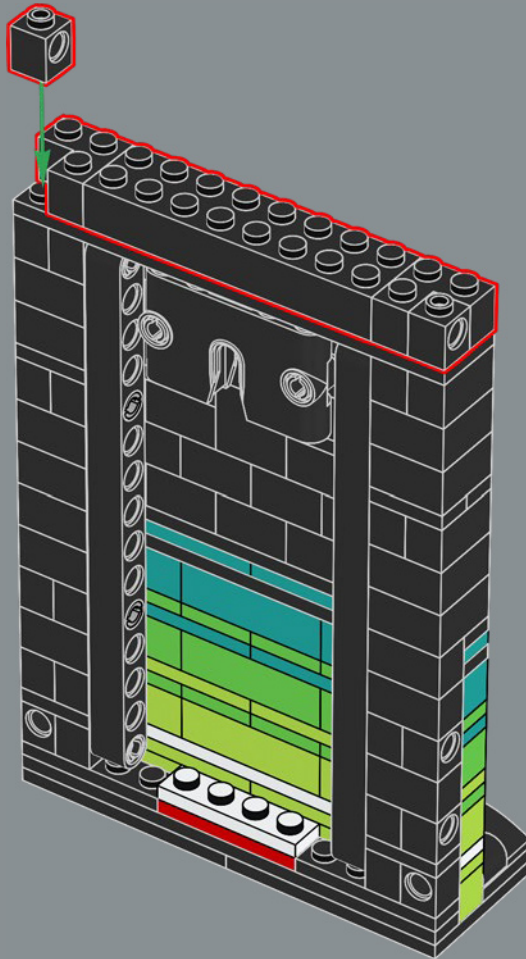

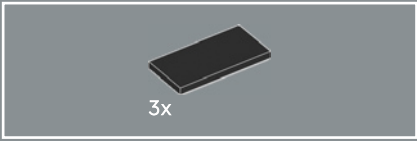

29

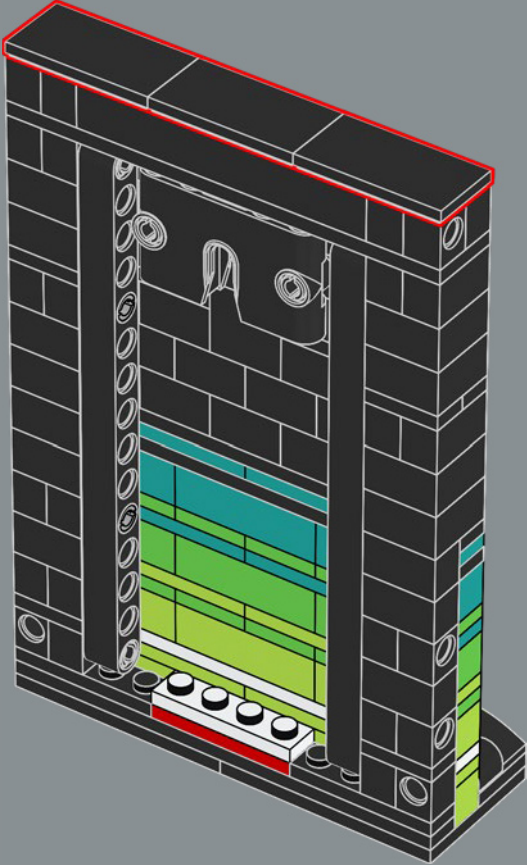

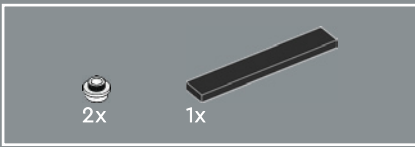

30

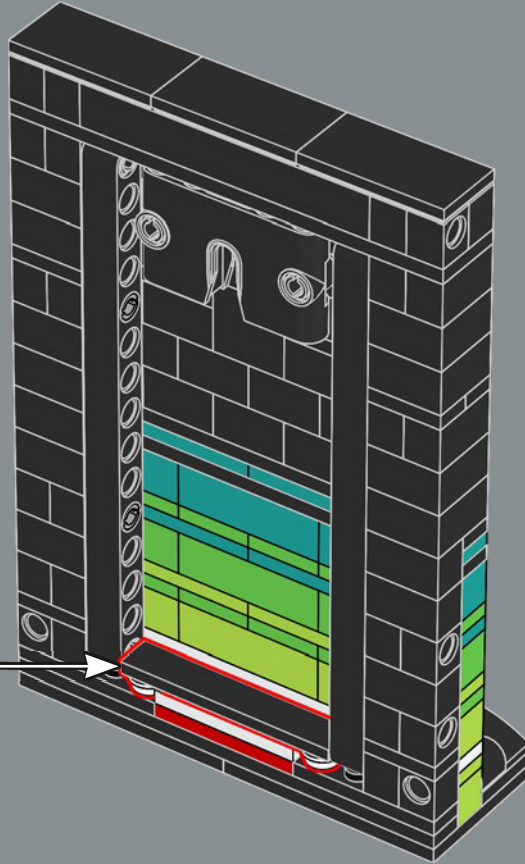
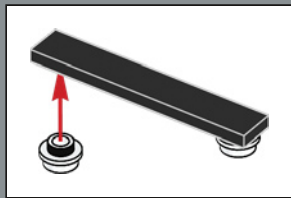

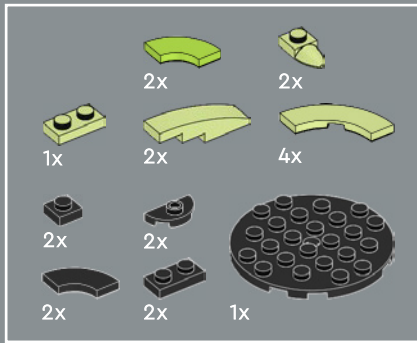

31

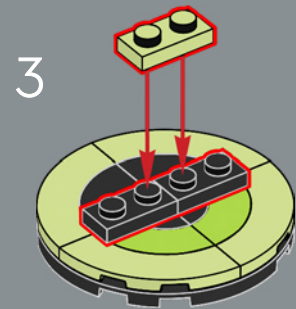
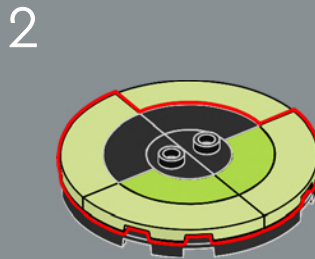
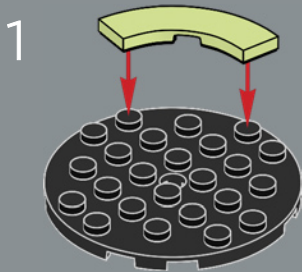

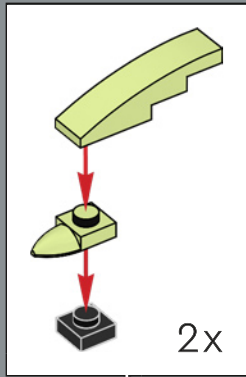

4

